

PIATTAFORME A CREMAGLIERA
PIATTAFORME AUTOSOLLEVANTI
ASCENSORI DA CANTIERE
RACK & PINION HOIST - MAST CLIMBING PLATFORM

www.tea-online.it • info.tea@nidec-tea.com



TEA International

A Kinetek Company®

PIATTAFORMA A CREMAGLIERA PER MATERIALI E PERSONE
RACK & PINION HOIST FOR MATERIALS AND PERSONS

PME400P

**FUNZIONANTE
CON RETE DOMESTICA
MONOFASE
WORKING WITH DOMESTIC
ELECTRIC SINGLE-PHASE NETWORK***

Colonna a sezione triangolari
ad alta resistenza
Heavy duty triangular mast

Sistema di avviso acustico
di sicurezza
Security acoustic warning
system

Ampia cassa di carico
1600x1000

Large transport basket
1600x1000mm

Discesa in sicurezza
nel tratto finale
Security final descent

Accesso e uscita
su due lati
Access/Loading by 2 sides

Griglia antischacciamento
di sicurezza
Anti-crush security grid

PIATTAFORME A CREMAGLIERA
PIATTAFORME AUTOSOLLEVANTI
ASCENSORI DA CANTIERE
RACK & PINION HOIST - MAST CLIMBING PLATFORM

www.tea-online.it • info.tea@nidec-tea.com



TEA International

A Kinetek Company®

PIATTAFORMA A CREMAGLIERA PER MATERIALI E PERSONE
RACK & PINION HOIST FOR MATERIALS AND PERSONS

PME400P

MONOFASE - SINGLEPHASE

Lunghezza piattaforma Platform length	1.600
Larghezza massima Maximum width	1.200
Velocità di salita Speed	12 m/min
Portata utile Maximum load	350 Kg
Altezza massima Maximum Height	120 m
Potenza motore resa Output power	2,5 kW
Intensità di corrente Current intensity	18 A
Peso corpo macchina Weight machine	823 kg
Sezione colonna Kind of section	

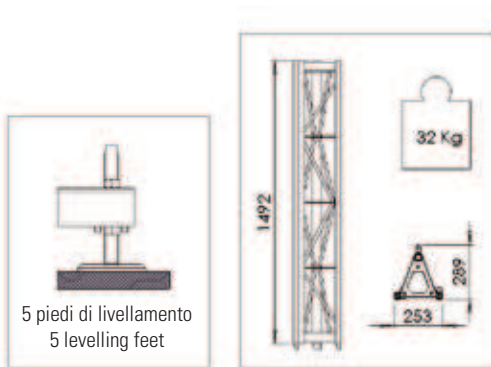

Modulo 5 - Module 5

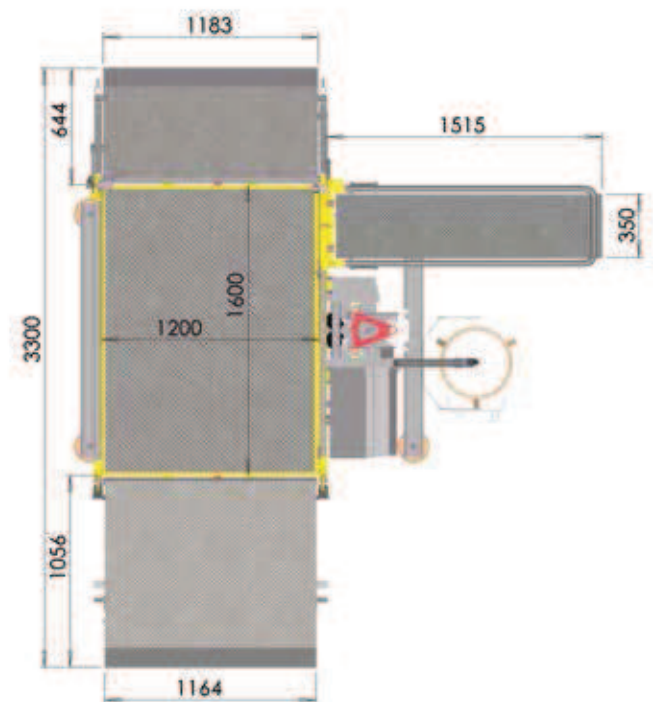
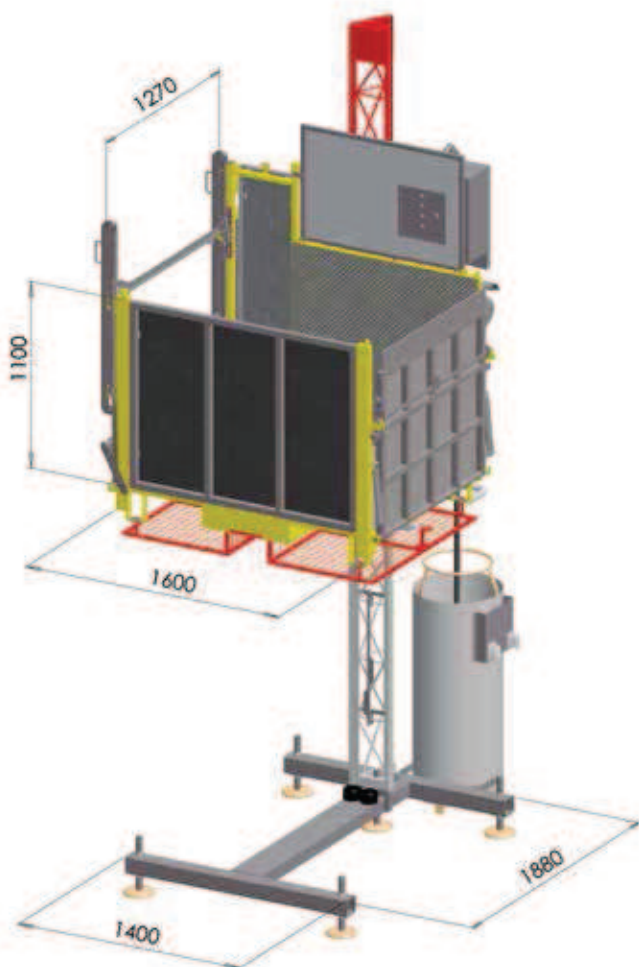

PIATTAFORME A CREMAGLIERA
PIATTAFORME AUTOSOLLEVANTI
ASCENSORI DA CANTIERE
RACK & PINION HOIST - MAST CLIMBING PLATFORM

www.tea-online.it • info.tea@nidec-tea.com



TEA International

A Kinetek Company®

PIATTAFORMA A CREMAGLIERA PER MATERIALI E PERSONE
RACK & PINION HOIST FOR MATERIALS AND PERSONS

PME400P

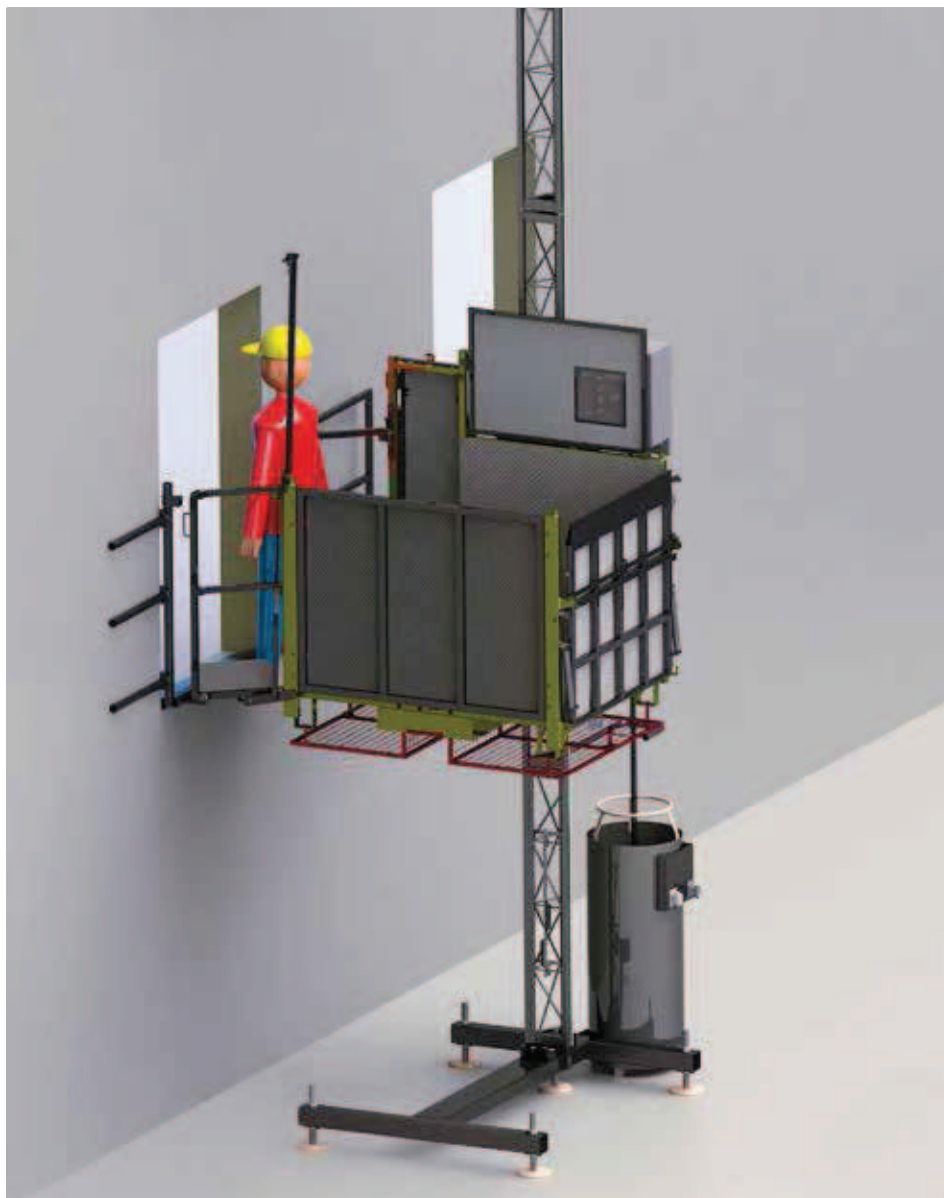

Esempio di installazione con fissaggio a parete e sbarco su finestra.

Example of installation with fixation on wall and landing gate through a window or through a balcony.



Passerella estensibile per facilitare il fissaggio a parete dei tasselli di supporto ancoraggi.

Telescopic gangway to facilitate assembling.



PIATTAFORMA A CREMAGLIERA PER MATERIALI E PERSONE
RACK & PINION HOIST FOR MATERIALS AND PERSONS

PME400P

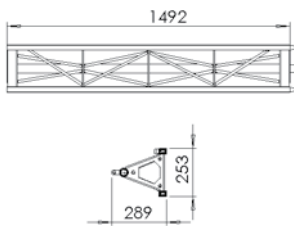

COD.	Denominazione / Name	Kg
PTE50000250	Colonna standard 1,5 m Standard Mast 1,5 m	30

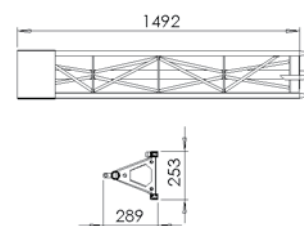

COD.	Denominazione / Name	Kg
PTE50000300	Colonna finale con finecorsa Final Stop Mast	29

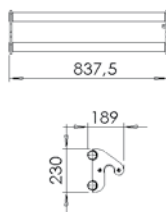

COD.	Denominazione / Name	Kg
PTE50001210	Ancoraggio ponteggio Scaffolding anchorage	8

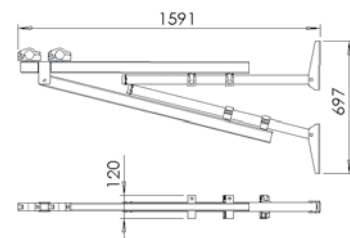

COD.	Denominazione / Name	Kg
PTE50001200	Ancoraggio regolabile+basculante Adjustable tilting anchorage	25

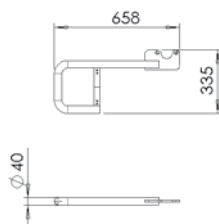

COD.	Denominazione / Name	Kg
PTE50001300	Guida cavo Cable Guide	3,3

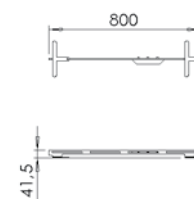

COD.	Denominazione / Name	Kg
PTE50000910	Fincorsa al piano Floor Stop	1,6

PIATTAFORME A CREMAGLIERA
 PIATTAFORME AUTOSOLLEVANTI
 ASCENSORI DA CANTIERE
 RACK & PINION HOIST - MAST CLIMBING PLATFORM

www.tea-online.it • info.tea@nidec-tea.com



TEA International

A Kinetek Company®

PIATTAFORMA A CREMAGLIERA PER MATERIALI E PERSONE
 RACK & PINION HOIST FOR MATERIALS AND PERSONS

PME400P

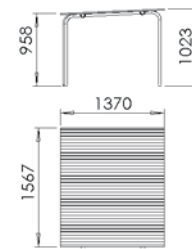
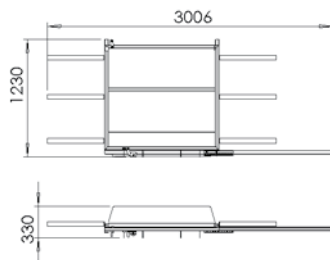

COD.	Denominazione / Name	Kg
PTE50001500	Cancelletto al piano Floor Gate	52

COD.	Denominazione / Name	Kg
PTE50001400	Tetto di protezione Basket Roof	37

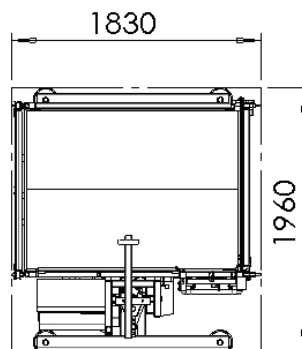
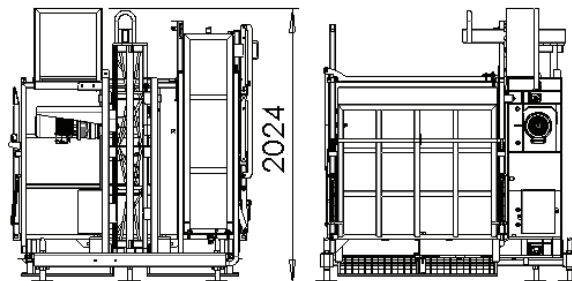

COD.	Denominazione / Name	Kg
PTE400P00	Equipaggiamento base / Basic Equipment	650