

PIATTAFORME A CREMAGLIERA  
PIATTAFORME AUTOSOLLEVANTI  
ASCENSORI DA CANTIERE  
RACK & PINION HOIST - MAST CLIMBING PLATFORM

[www.tea-online.it](http://www.tea-online.it) • [info.tea@nidec-tea.com](mailto:info.tea@nidec-tea.com)



**TEA International**

A Kinetek Company®

ASCENSORE DA CANTIERE PER MATERIALI E PERSONE  
RACK & PINION HOIST FOR MATERIALS AND PERSONS

**PTE1500P**

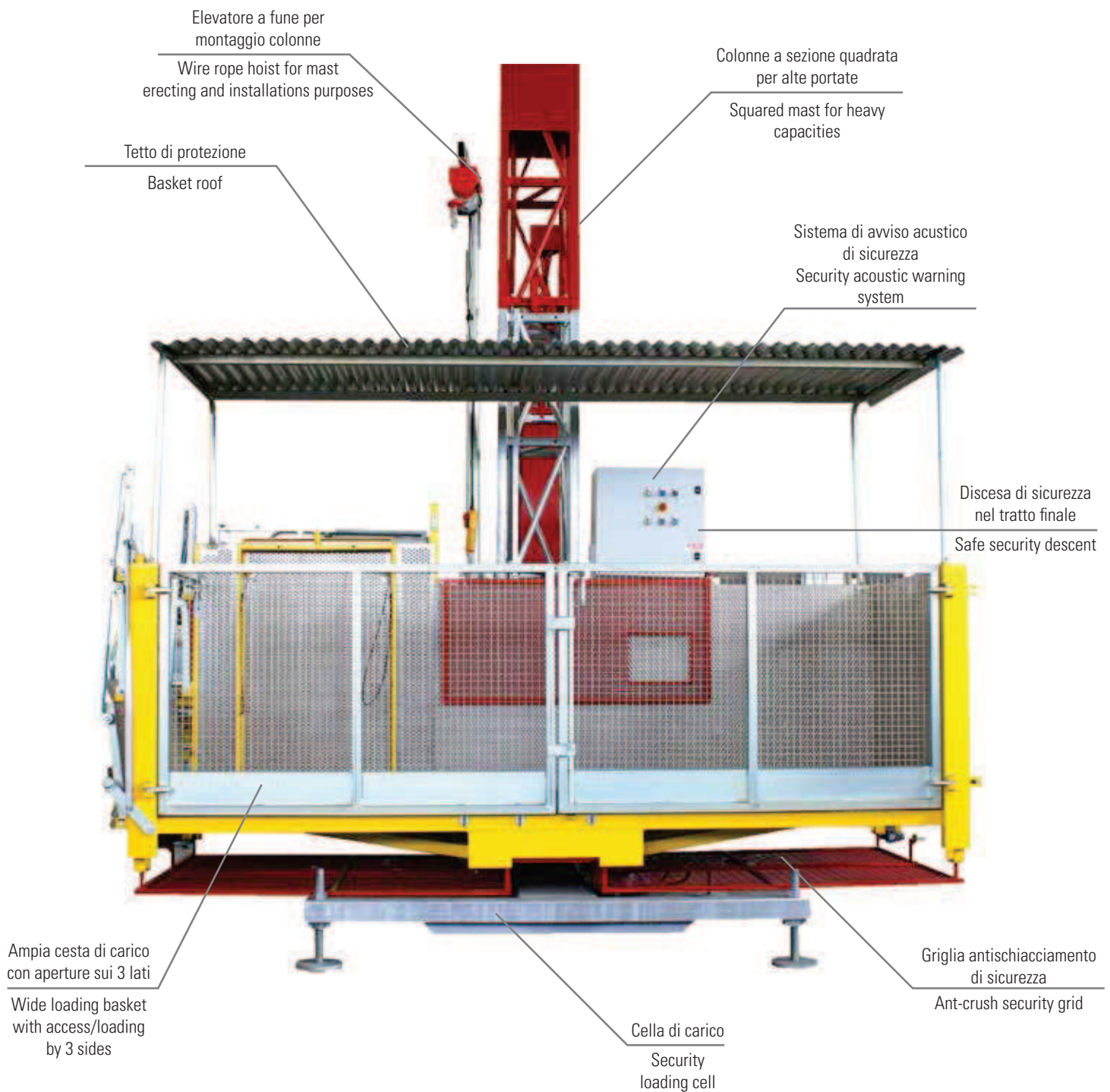

PIATTAFORME A CREMAGLIERA  
PIATTAFORME AUTOSOLLEVANTI  
ASCENSORI DA CANTIERE  
RACK & PINION HOIST - MAST CLIMBING PLATFORM

www.tea-online.it • info.tea@nidec-tea.com



**TEA International**

A Kinetek Company®

ASCENSORE DA CANTIERE PER MATERIALI E PERSONE  
RACK & PINION HOIST FOR MATERIALS AND PERSONS

**PTE1500P**

**TRIFASE - THREEPHASE**

|  |                          |
|--|--------------------------|
| Lunghezza piattaforma<br>Platform length   | 3.700 mm                 |
| Larghezza massima<br>Maximum width         | 1.400 mm                 |
| Velocità di salita<br>Speed                | *12-**24<br>m/min        |
| Portata utile<br>Maximum load              | 1500 Kg                  |
| Altezza massima<br>Maximum Height          | 150 m                    |
| Potenza motore resa<br>Output power        | 2x8 kW                   |
| Intensità di corrente<br>Current intensity | 41 A                     |
| Peso corpo macchina<br>Weight machine      | 1.660 kg                 |
| <b>Sezione colonna<br/>Kind of section</b> | <input type="checkbox"/> |

\* 12m/min trasporto persone/ persons transportation  
\*\* 24m/min trasporto materiali / only material transportation

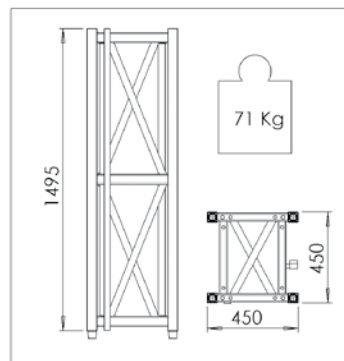
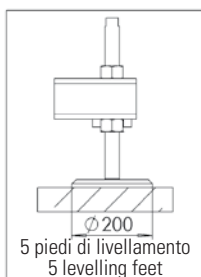

Modulo 7 - Module 7

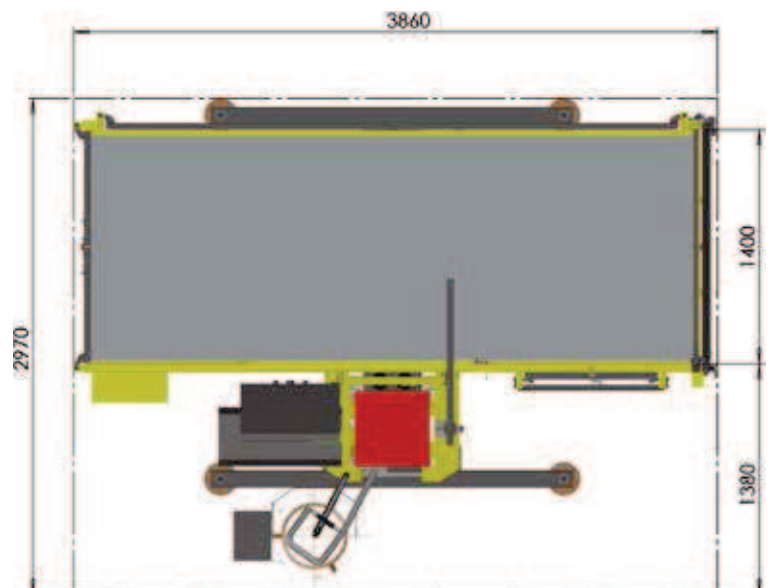
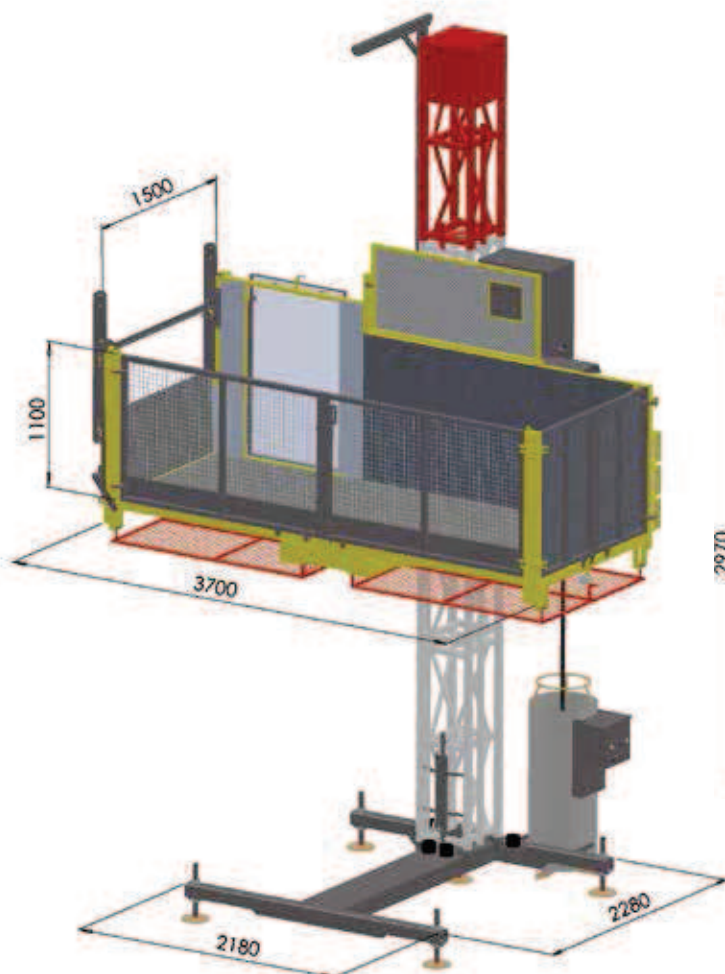

PIATTAFORME A CREMAGLIERA  
PIATTAFORME AUTOSOLLEVANTI  
ASCENSORI DA CANTIERE  
RACK & PINION HOIST - MAST CLIMBING PLATFORM

[www.tea-online.it](http://www.tea-online.it) • [info.tea@nidec-tea.com](mailto:info.tea@nidec-tea.com)



**TEA International**

A Kinetek Company®

ASCENSORE DA CANTIERE PER MATERIALI E PERSONE  
RACK & PINION HOIST FOR MATERIALS AND PERSONS

## PTE1500P

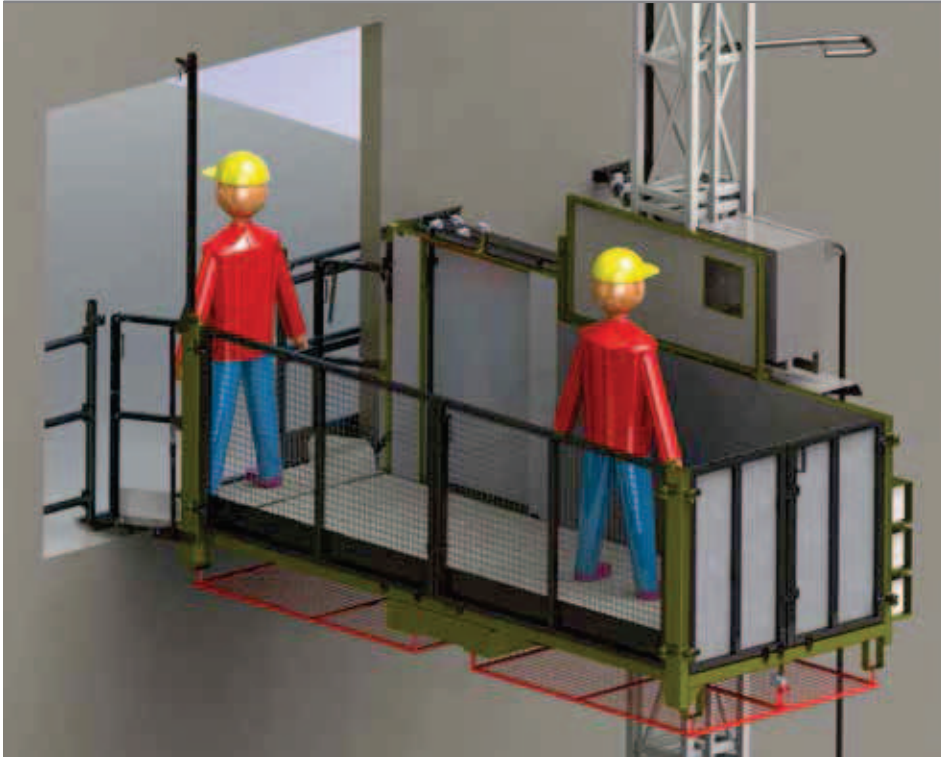

Esempio di installazione con fissaggio a parete e sbarco su finestra.

Example of installation with fixation on wall and landing gate through a window or through a balcony.



Passerella estensibile per facilitare il fissaggio a parete dei tasselli di supporto ancoraggi.

Telescopic gangway to facilitate assembling.



ASCENSORE DA CANTIERE PER MATERIALI E PERSONE  
RACK & PINION HOIST FOR MATERIALS AND PERSONS

**PTE1500P**

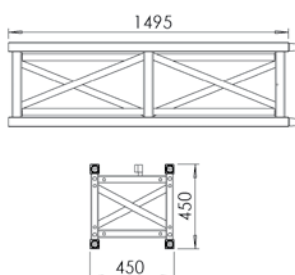

| COD.        | Denominazione / Name                          | Kg |
|-------------|---|----|
| PTE15000250 | Colonna standard 1,5 m<br>Standard Mast 1,5 m | 30 |

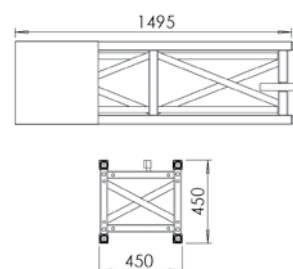

| COD.        | Denominazione / Name                            | Kg |
|-------------|---|----|
| PTE15000300 | Colonna finale con finecorsa<br>Final Stop Mast | 29 |

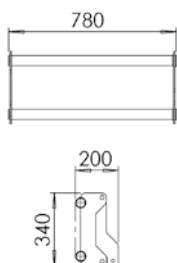

| COD.        | Denominazione / Name                 | Kg |
|-------------|--------------------------------------|----|
| PTE15001210 | Supporto ancoraggio<br>Anchorage tie | 8  |

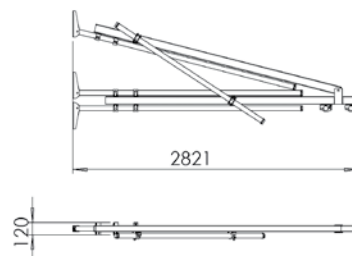

| COD.        | Denominazione / Name   | Kg |
|-------------|--|----|
| PTE15001200 | Ancoraggio regolabile+basculante<br>Adjustable tilting anchorage | 25 |

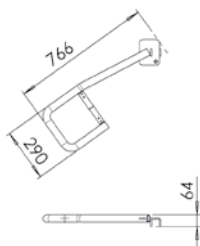

| COD.        | Denominazione / Name      | Kg  |
|-------------|---------------------------|-----|
| PTE15001300 | Guida cavo<br>Cable Guide | 3,3 |

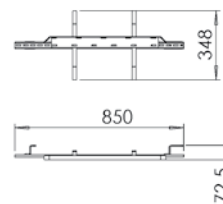

| COD.        | Denominazione / Name             | Kg  |
|-------------|----------------------------------|-----|
| PTE15000910 | Finecorsa al piano<br>Floor Stop | 1,6 |



ASCENSORE DA CANTIERE PER MATERIALI E PERSONE  
 RACK & PINION HOIST FOR MATERIALS AND PERSONS

**PTE1500P**

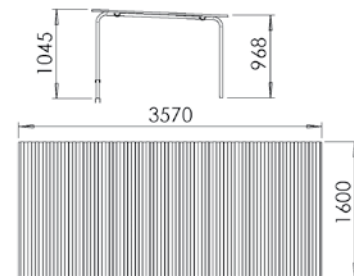
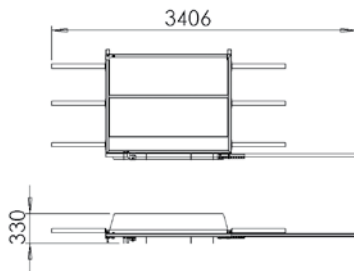

| COD.        | Denominazione / Name               | Kg |
|-------------|------------------------------------|----|
| PTE15001500 | Cancelletto al piano<br>Floor Gate | 56 |

| COD.        | Denominazione / Name               | Kg |
|-------------|------------------------------------|----|
| PTE15001400 | Tetto di protezione<br>Basket roof | 44 |

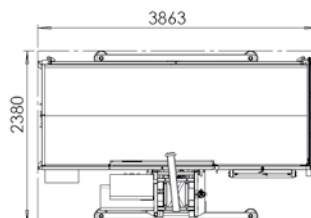
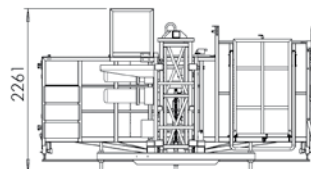

| COD.       | Denominazione / Name                   | Kg  |
|------------|--|-----|
| PTE1500P00 | Equipaggiamento base / Basic Equipment | 650 |