

PIATTAFORME A CREMAGLIERA  
PIATTAFORME AUTOSOLLEVANTI  
ASCENSORI DA CANTIERE  
RACK & PINION HOIST - MAST CLIMBING PLATFORM

[www.tea-online.it](http://www.tea-online.it) • [info.tea@nidec-tea.com](mailto:info.tea@nidec-tea.com)



**TEA International**

A Kinetek Company®

PIATTAFORMA A CREMAGLIERA PER MATERIALI E PERSONE  
RACK & PINION HOIST FOR MATERIALS AND PERSONS

**PTE500P**

Colonna a sezione triangolare  
ad alta resistenza  
Heavy duty triangular mast

Sistema di avviso acustico  
di sicurezza  
Security acoustic warning  
system

Discesa di sicurezza  
nel tratto finale  
Security final descent

Accesso/Uscita  
su entrambi i lati  
Access/loading by 2 sides

Cella di carico  
di sicurezza  
Security loading cell

Griglia antischacciamento  
di sicurezza  
Anti-crush security grid





PIATTAFORMA A CREMAGLIERA PER MATERIALI E PERSONE  
RACK & PINION HOIST FOR MATERIALS AND PERSONS

**PTE500P**

**TRIFASE - THREEPHASE**

Lunghezza piattaforma Platform length	1.600 mm
Larghezza massima Maximum width	1.100 mm
Velocità di salita Speed	12 m/min
Portata utile Maximum load	500 Kg
Altezza massima Maximum Height	120 m
Potenza motore resa Output power	2,5 kW
Intensità di corrente Current intensity	6,3 A
Peso corpo macchina Weight machine	823 kg
<b>Sezione colonna Kind of section</b>	

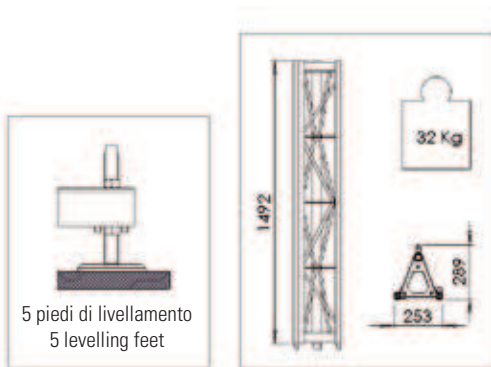

Modulo 5 - Module 5

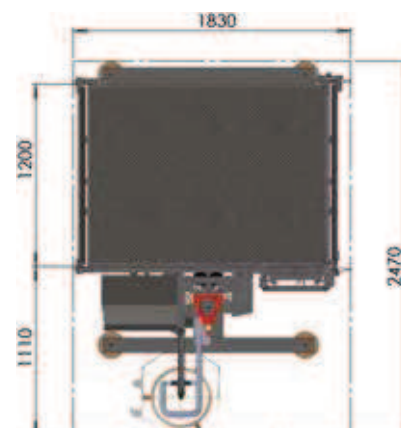
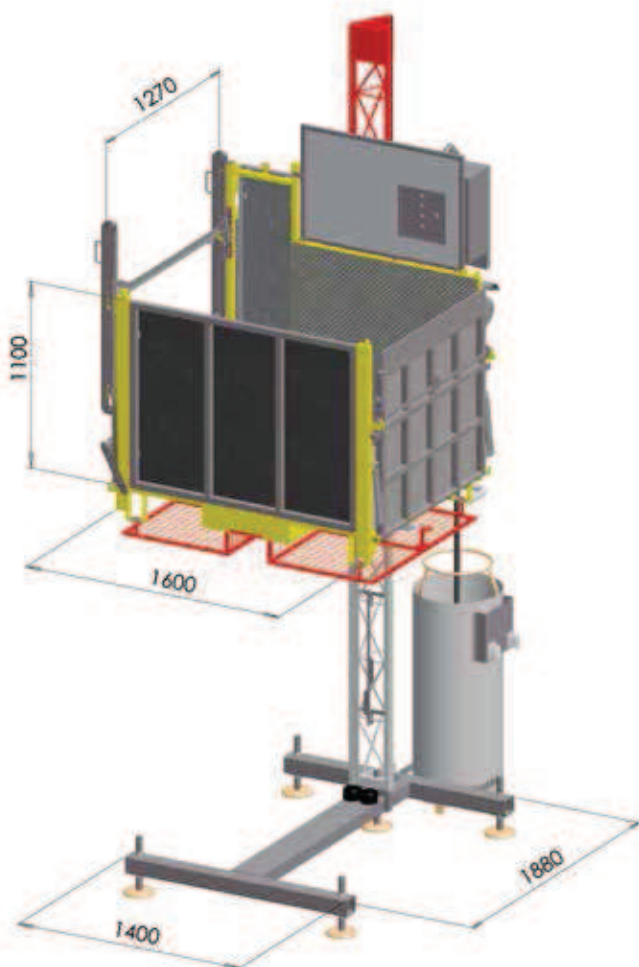

PIATTAFORME A CREMAGLIERA  
PIATTAFORME AUTOSOLLEVANTI  
ASCENSORI DA CANTIERE  
RACK & PINION HOIST - MAST CLIMBING PLATFORM

[www.tea-online.it](http://www.tea-online.it) • [info.tea@nidec-tea.com](mailto:info.tea@nidec-tea.com)



**TEA International**

A Kinetek Company®

PIATTAFORMA A CREMAGLIERA PER MATERIALI E PERSONE  
RACK & PINION HOIST FOR MATERIALS AND PERSONS

## PTE500P

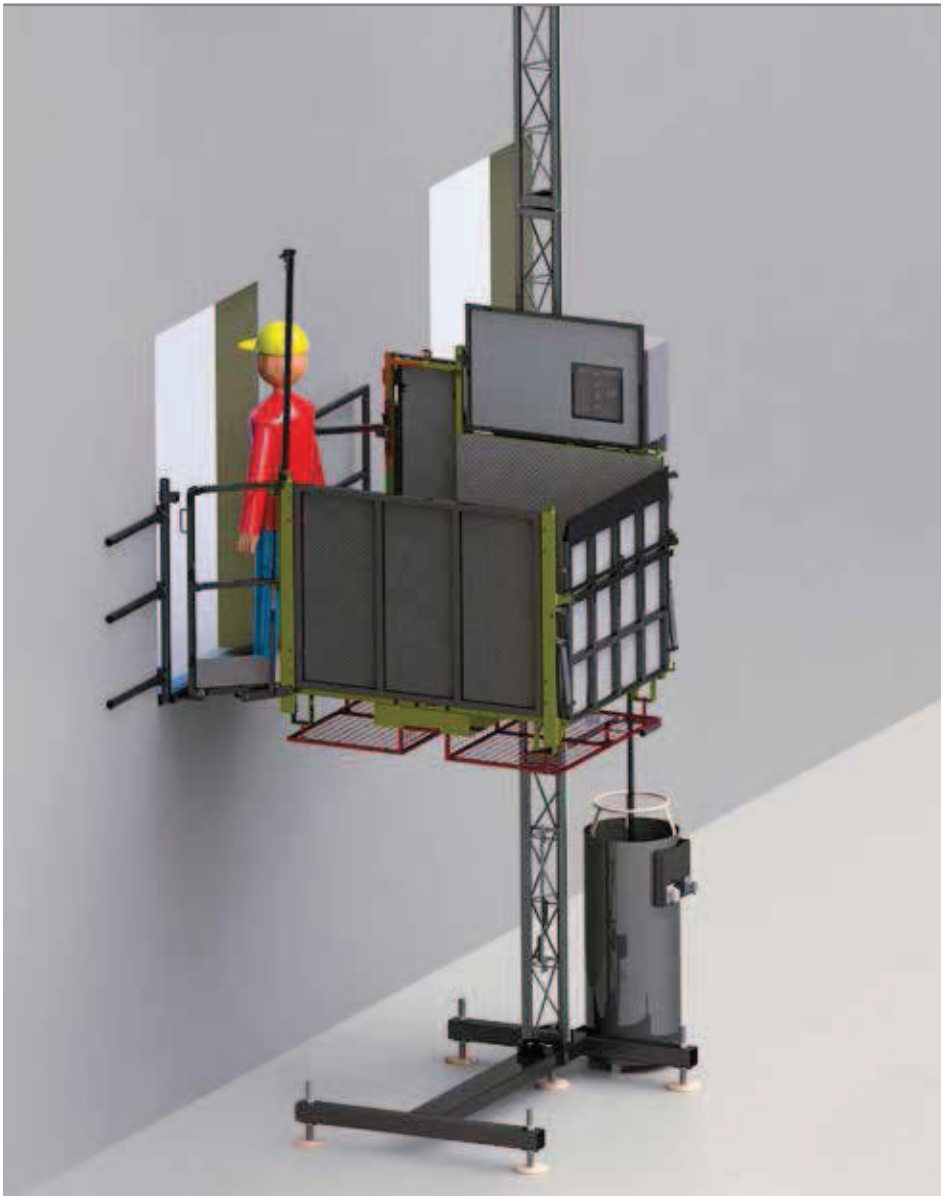

Esempio di installazione con fissaggio a parete e sbarco su finestra.

Example of installation with fixation on wall and landing gate through a window or through a balcony.



Passerella estensibile per facilitare il fissaggio a parete dei tasselli di supporto ancoraggi.

Telescopic gangway to facilitate assembling.



PIATTAFORMA A CREMAGLIERA PER MATERIALI E PERSONE  
RACK & PINION HOIST FOR MATERIALS AND PERSONS

**PTE500P**

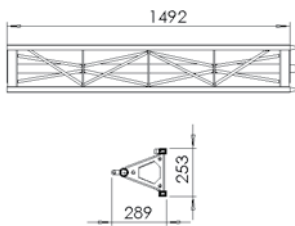

COD.	Denominazione / Name	Kg
PTE50000250	Colonna standard 1,5 m Standard Mast 1,5 m	30

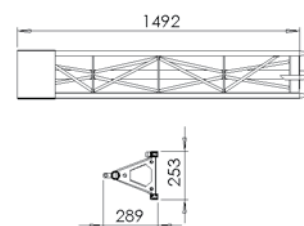

COD.	Denominazione / Name	Kg
PTE50000300	Colonna finale con finecorsa Final Stop Mast	29

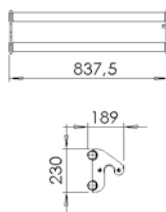

COD.	Denominazione / Name	Kg
PTE50001210	Supporto ancoraggio Anchorage tie	8

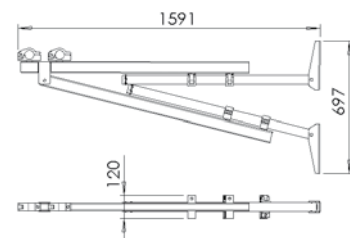

COD.	Denominazione / Name	Kg
PTE50001200	Ancoraggio regolabile+basculante Adjustable tilting anchorage	25

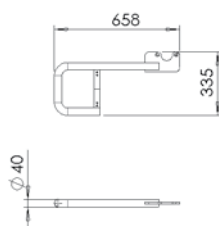

COD.	Denominazione / Name	Kg
PTE50001300	Guida cavo Cable Guide	3,3

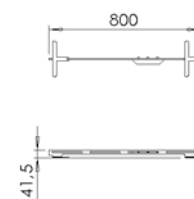

COD.	Denominazione / Name	Kg
PTE50000910	Fincorsa al piano Floor Stop	1,6

PIATTAFORME A CREMAGLIERA  
PIATTAFORME AUTOSOLLEVANTI  
ASCENSORI DA CANTIERE  
RACK & PINION HOIST - MAST CLIMBING PLATFORM

[www.tea-online.it](http://www.tea-online.it) • [info.tea@nidec-tea.com](mailto:info.tea@nidec-tea.com)



**TEA International**

A Kinetek Company®

PIATTAFORMA A CREMAGLIERA PER MATERIALI E PERSONE  
RACK & PINION HOIST FOR MATERIALS AND PERSONS

**PTE500P**

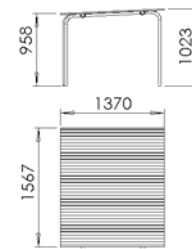
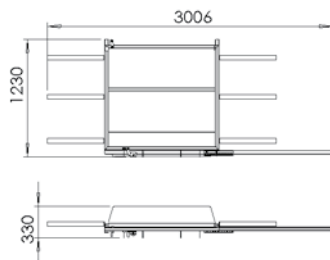

COD.	Denominazione / Name	Kg
PTE50001500	Cancelletto al piano Floor Gate	52

COD.	Denominazione / Name	Kg
PTE50001400	Tetto di protezione Basket Roof	37

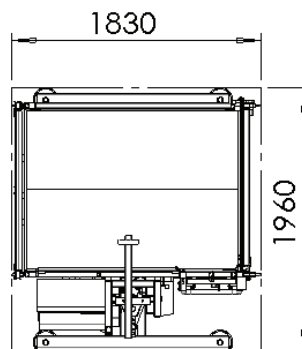
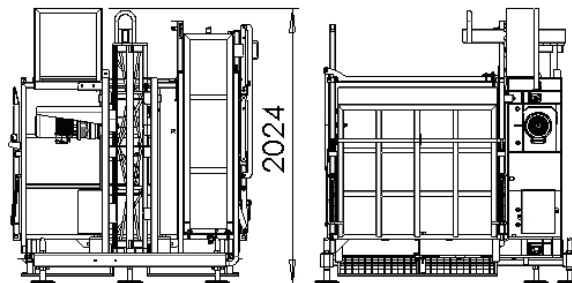

COD.	Denominazione / Name	Kg
PTE500P00	Equipaggiamento base / Basic Equipment	650